



**INSTITUTO DE CIENCIAS
DE LA CONSTRUCCIÓN
EDUARDO TORROJA**

C/ Serrano Galvache n. 4 28033 Madrid (Spain)
Tel.: (34) 91 302 04 40 Fax: (34) 91 302 07 00
direccion.ietcc@csic.es https://dit.ietcc.csic.es

European Technical Assessment

ETA 20/0046 of 18/03/2022

English translation prepared by IETcc. Original version in Spanish language

General Part

Technical Assessment Body issuing the ETA designated according to Art. 29 of Regulation (EU) 305/2011:

Instituto de Ciencias de la Construcción Eduardo Torroja (IETcc)

Trade name of the construction product:

Screw anchor THE

Product family to which the construction product belongs:

Screw anchor of sizes 6, 8, 10, 12, 14 and 18 for use in concrete.

Manufacturer:

Index - Técnicas Expansivas S.L.
Segador 13
26006 Logroño (La Rioja) Spain.
website: www.indexfix.com

Manufacturing plant:

Index plant 2

This European Technical Assessment contains:

16 pages including 3 annexes which form an integral part of this assessment.

This European Technical Assessment is issued in accordance with regulation (EU) No 305/2011, on the basis of:

European Technical Assessment EAD 330232-00-0601 "Mechanical Fasteners for use in concrete", ed. October 2016

This ETA replaces:

ETA 20/0046 issued 02/08/2021

English translation prepared by IETcc

This European Technical Assessment is issued by the Technical Assessment Body in its official language. Translations of this European Technical Assessment in other languages shall fully correspond to the original issued document and should be identified as such.

This European Technical Assessment may be withdrawn by the issuing Technical Assessment Body, in particular pursuant to information by the Commission according to article 25 (3) of Regulation (EU) No 305/2011.

SPECIFIC PART

1. Technical description of the product

The Index screw anchor THE is a fastener made of carbon steel of sizes 6, 8, 10, 12, 14 and 18. The fastener is installed into a predrilled cylindrical hole. The special thread of the fastener cuts an internal thread into the concrete member while setting. The anchorage is characterised by mechanical interlock between fastener and concrete.

Product and installation descriptions are given in annex A.

2. Specification of the intended use in accordance with the applicable European Assessment Document.

The performances given in section 3 are only valid if the anchor is used in compliance with the specifications and conditions given in annex B.

The verifications and assessment methods on which this European Technical Assessment is based lead to the assumption of a working life of the anchor of at least 50 years. The indications given on the working life cannot be interpreted as a guarantee given by the producer, but are to be regarded only as a mean to choosing the right products in relation to the expected economically reasonable working life of the works.

3. Performance of the product and references to the methods used for its assessment

3.1 Mechanical resistance and stability (BWR 1)

Essential characteristic	Performance
Essential characteristic under static or quasi static loading	See annexes C3 and C4
Displacements under tension and shear loads	See annex C5
Essential characteristic and displacements for seismic performance categories C1 and C2	See annexes C6 and C7

3.2 Safety in case of fire (BWR 2)

Essential characteristic	Performance
Reaction to fire	Anchorage satisfy requirements for class A1
Essential characteristics under fire exposure	See annexes C8 and C9

English translation prepared by IETcc

4. Assessment and Verification of Constancy of Performances (hereinafter AVCP) system applied, with reference to its legal base

The applicable European legal act for the system of Assessment and Verification of Constancy of Performances (see annex V to Regulation (EU) No 305/2011) is 96/582/EC.

The system to be applied is 1.

5. Technical details necessary for the implementation of the AVCP system, as provided for in the applicable European Assessment Document.

The technical details necessary for the implementation of the AVCP system are laid down in the quality plan deposited at Instituto de Ciencias de la Construcción Eduardo Torroja.



Instituto de Ciencias de la Construcción Eduardo Torroja
CONSEJO SUPERIOR DE INVESTIGACIONES CIENTÍFICAS

C/ Serrano Galvache n.º 4. 28033 Madrid.
Tel: (+34) 91 302 04 40 Fax. (+34) 91 302 07 00
<https://dit.ietcc.csic.es>







On behalf of the Instituto de Ciencias de la Construcción Eduardo Torroja
Madrid, 18^h of March 2021

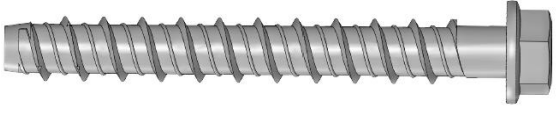
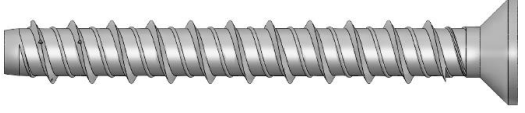
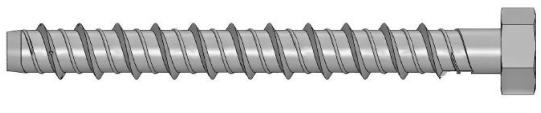

Director IETcc-CSIC

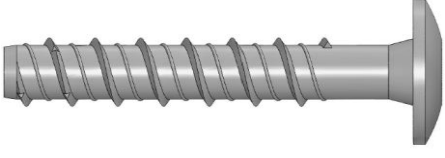
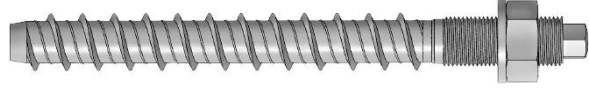
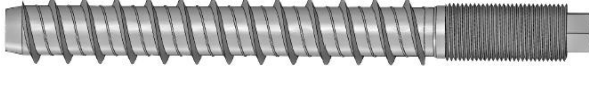
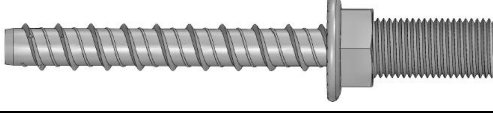
English translation prepared by IETcc

Product types			
Picture	Sizes	Code	Coating
	Hexagonal head with flange. Sizes: 6, 8, 10, 12, 14 and 18	THE, THK	Atlantis
		TFE, TFK	Zinc plated
		TNE, TNK	Zinc nickel
		TKE, TKK	Zinc flake
		TGE, TGK	Mech. galv.
	Countersunk, Six lob recess Sizes: 6, 8 10 and 12	THA	Atlantis
		TFA	Zinc plated
		TNA	Zinc nickel
		TKA	Zinc flake
		TGA	Mech. galv.
	Hexagonal head. Sizes: 6, 8, 10, 12, 14 and 18	THN	Atlantis
		TFN	Zinc plated
		TNN	Zinc nickel
		TKN	Zinc flake
		TGN	Mech. galv.
	Pan head. Six lob recess Sizes: 6 and 8	THP	Atlantis
		TFP	Zinc plated
		TNP	Zinc nickel
		TKP	Zinc flake
		TGP	Mech. galv.
	Truss head. Six lob recess. Size: 6	THT	Atlantis
		TFT	Zinc plated
		TNT	Zinc nickel
		TKT	Zinc flake
		TGT	Mech. galv.
	Stud head with DIN 934 class 6 nut and DIN 125 washer Sizes: 6, 8 and 10	TFW	Zinc plated
		TNW	Zinc nickel
		TKW	Zinc flake
	Stud head Sizes: 6, 8 and 10	TFS	Zinc plated
		TNS	Zinc nickel
		TKS	Zinc flake
	Male thread Size: 6, external thread M8; M10	TFM	Zinc plated
		TNM	Zinc nickel
		TKM	Zinc flake
	Rod hanger Size 6: thread M8 / M10 Size 8: thread M10, M12 Size 10: thread M12 Size 12: thread M12	TFF	Zinc plated
		TNF	Zinc nickel
		TKF	Zinc flake
		TGF	Mech. galv.
THE screw anchor			Annex A1
Product description			
Screw types			

English translation prepared by IETcc

Installed condition

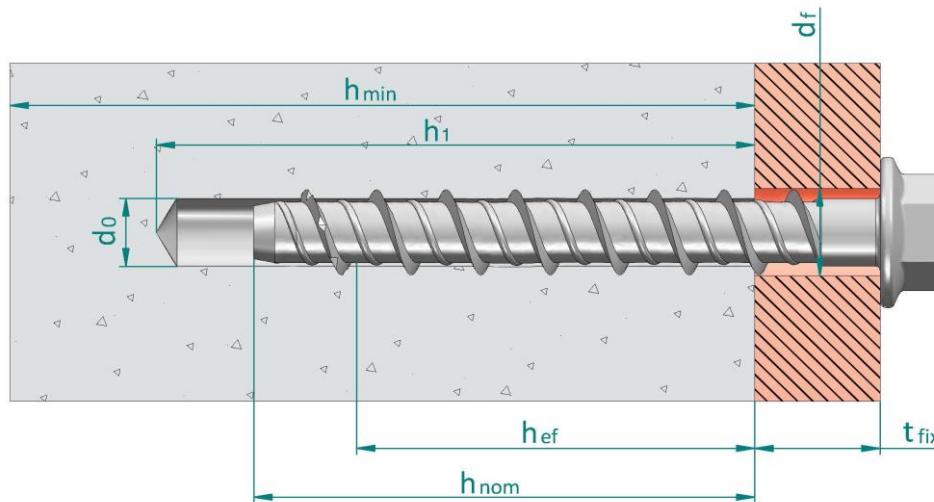

- d₀: Nominal diameter of drill bit
- d_r: Fixture clearance hole diameter
- h_{ef}: Effective anchorage depth
- h₁: Depth of drilled hole
- h_{nom}: Overall fastener embedment depth in the concrete
- h_{min}: Minimum thickness of concrete member
- t_{fix}: Fixture thickness

Identification on head of fastener: company logo + size x length

The tip of the thread may be coloured

For heads where no space enough space is available, length mark can be replaced by the following letter codes.

Letter on head	Length [mm]
A	35 ÷ 50
B	51 ÷ 62
C	63 ÷ 75
D	76 ÷ 88
E	89 ÷ 101
F	102 ÷ 113
G	114 ÷ 126
H	127 ÷ 139
I	140 ÷ 153

Table A1: Materials

Item	Designation	Material for screw anchor
1	Fastener body	Carbon steel, galvanized ≥ 5 µm ISO 4042 Zn5 Carbon steel, zinc nickel ≥ 8 µm ISO 4042, ZnNi8/An/T2 Carbon steel, zinc flake ≥ 6 µm ISO 10683 Carbon steel, mechanical galvanizing ≥ 40 µm EN ISO 12683 Zn 40 M(Fe) Carbon steel, Atlantis coating

THE screw anchor

Product description

Installed condition and materials

**Annex
A2**

Specifications of intended use

Anchorage subjected to:

- Static or quasi static loads: all sizes and embedment depths.
- Seismic action for performance categories C1 & C2 as per table below

Size	6			8		10			12		14		18	
h_{nom}	35	40	55	50	65	55	75	85	75	105	75	115	90	140
C1		✓	✓	✓	✓			✓		✓		✓		✓
C2				✓	✓			✓		✓		✓		✓

- Resistance to fire exposure up to 120 minutes: all sizes and embedment depths.

Base materials:

- Reinforced or unreinforced normal weight concrete without fibres according to EN 206:2013 + A1:2016.
- Strength classes C20/25 to C50/60 according to EN 206:2013 + A1:2016.
- Cracked or uncracked concrete.

Use conditions:

- Environmental conditions: anchorages subjected to dry internal conditions.
- TFM, TFF: the metric thread shall be equal or bigger than the net section of the concrete thread

Design:

- Anchorages are designed under the responsibility of an engineer experienced in anchorages and concrete work.
- Verifiable calculation rules and drawings are prepared taking into account of the loads to be anchored. The position of the fastener is indicated on the design drawings (e.g. position of the fastener relative to reinforcement or to supports, etc.).
- Anchorages under static or quasi static actions are designed for design method A in accordance with EN 1992-4:2018.
- Anchorages under seismic actions are designed in accordance with EN 1992-4:2018. Anchorages shall be positioned outside of critical regions (e.g. plastic hinges) of the concrete structure. Fastening in stand-off installation or with grout layer are not allowed.
- Anchorages under fire exposure are designed in accordance with EN 1992-4:2018. It must be ensured that local spalling of the concrete cover does not occur.
- Size 6 in shallow embedment depth (35 mm) shall be used for statically indeterminate structural components only, when in case of failure the load can be distributed to other fasteners

Installation:

- Hole drilling by rotary plus hammer mode: all sizes and embedment depths.
- Fastener installation carried out by appropriately qualified personal and under the supervision of the person responsible for technical matters of the site.
- In case of aborted hole: new drilling at a minimum distance away of twice the depth of aborted hole or smaller distance if the aborted hole is filled with high strength mortar and if under shear or oblique tension load it is not the direction of the load application.
- After installation further turning of the anchor must not be possible.
- The head of the fastener must be supported on the fixture and is not damaged.

THE screw anchor

Intended use

Specifications

**Annex
B1**

English translation prepared by IETcc

Table C1: Installation parameters

Installation parameters			Performances								
			6			8		10			
h_{nom}	Nominal embedment depth:	[mm]	35	40	55	50	65	55	75	85	
h_{ef}	Effective anchorage depth:	[mm]	26,0	30,0	43,0	37,5	50,5	41,5	58,5	67,0	
d_0	Nominal diameter of drill bit:	[mm]	6			8		10			
d_f	Clearance hole diameter \leq	[mm]	9			12		14			
$T_{inst,max}$	Installation torque \leq	[Nm]	10			20		30			
h_1	Depth of drilled hole \geq	[mm]	45	50	65	60	75	65	85	95	
h_{min}	Minimum thickness of concrete member:	[mm]	100	100	100	100	100	100	120	135	
L_{min}	Minimum total length of the fastener:	[mm]	35	40	55	50	65	55	75	85	
t_{fix}	Thickness of fixture ¹⁾ :	[mm]	L-35	L-40	L-55	L-50	L-65	L-55	L-75	L-85	
SW	Socket size	Hexagonal type E:	10			13		15			
		Hexagonal type K:	10			13		17			
		Male:	13			13		--			
		Rod hanger:	M6: 10; M8: 11; M8/M10: 13; M10: 13; M12: 15								
		Stud:	5			7		8			
TX	Six lob recess	Countersunk:	30			45		50			
		Pan:	40			45		--			
		Truss:	30			--		--			
d_k	Diameter of countersunk head:	[mm]	12,4			18		21			
s_{min}	Minimum allowable spacing:	[mm]	35			35		50			
c_{min}	Minimum allowable distance:	[mm]	35			35		40			
Setting tool			Bosch GDS 18E, 500 W. $T_{impact,max}$ 250 Nm, or equivalent								

¹⁾ L = total fastener length

Installation parameters			Performances					
			12		14		18	
h_{nom}	Nominal embedment depth:	[mm]	75	105	75	115	90	140
h_{ef}	Effective anchorage depth:	[mm]	58,0	83,5	58,0	92,0	69,5	112,0
d_0	Nominal diameter of drill bit:	[mm]	12		14		18	
d_f	Clearance hole diameter \leq	[mm]	16		18		22	
$T_{inst,max}$	Installation torque \leq	[Nm]	50		70		90	
h_1	Depth of drilled hole \geq	[mm]	90	120	90	130	110	160
h_{min}	Minimum thickness of concrete member:	[mm]	120	170	120	185	140	225
L_{min}	Minimum total length of the fastener:	[mm]	75	105	75	115	90	140
t_{fix}	Thickness of fixture ¹⁾ :	[mm]	L-75	L-105	L-75	L-115	L-90	L-140
SW	Socket size:	Hexagonal type E:	18		21		24	
		Hexagonal type K:	19		21		26	
		Rod hanger:	15		--		--	
TX	Six lob recess countersunk	55		--		--		
d_k	Diameter of countersunk head:	[mm]	24		--		--	
s_{min}	Minimum allowable spacing:	[mm]	75		80		90	
c_{min}	Minimum allowable distance:	[mm]	45		50		55	
Setting tool			Bosch GDS 24, 800 W. $T_{impact,max}$ 600 Nm, or equivalent					

¹⁾ L = total fastener length

THE screw anchor

Performances

Installation parameters

**Annex
C1**

Installation procedure

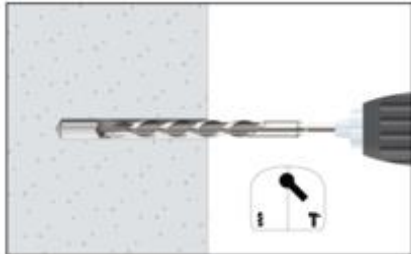

1. DRILL

Drill a hole into the base material of the correct diameter and depth using a carbide drill bit in rotary plus hammer mode.



2. BLOW AND CLEAN

Remove dust and debris from hole using a hand pump, compressed air or a vacuum to remove loose particles left from drilling.

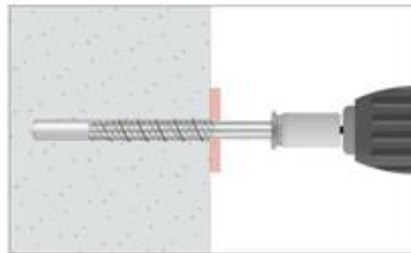

3. INSTALL

Select a powered impact wrench or a torque wrench that does not exceed the maximum torque $T_{impact,max}$ or $T_{inst,max}$ respectively. Attach an appropriately sized hex socket or six lob bit to the wrench. Mount the screw anchor head in the socket / bit.

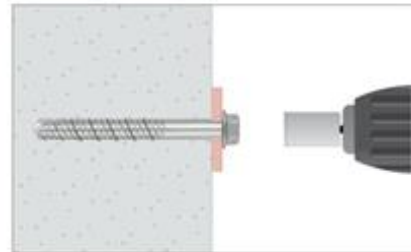

4. APPLY TORQUE

Drive the anchor with an impact driver or a torque wrench through the fixture and into the hole until the anchor head comes in contact with the fixture. The anchor must be snug after installation. Do not spin the socket off the anchor to disengage.

THE screw anchor	Annex C2
Performances	
Installation procedure	

English translation prepared by IETcc

Table C2: Essential characteristics under static or quasi-static tension loads of design method A according to EN1992-4

Essential characteristics under static or quasi-static tension loads according to design method A				Performances							
				6			8		10		
h_{nom}	Nominal embedment depth:	[mm]		35	40	55	50	65	55	75	85
Tension loads: steel failure											
$N_{Rk,s}$	Characteristic resistance:	[kN]		25,12			39,14		54,81		
γ_{Ms}	Partial safety factor ¹⁾ :	[-]		1,4							
Tension loads: pull-out failure in concrete											
$N_{Rk,p}$	Characteristic resistance in C20/25 uncracked concrete:	[kN]	5	2)							
$N_{Rk,p}$	Characteristic resistance in C20/25 cracked concrete:	[kN]		2)							
ψ_c	Increasing factor for concrete	C30/37	[-]	1,16	1,12	1,22	1,21	1,22	1,22	1,17	1,22
		C40/50	[-]	1,28	1,22	1,41	1,39	1,41	1,41	1,30	1,41
		C50/60	[-]	1,39	1,29	1,58	1,54	1,58	1,58	1,42	1,58
Tension loads: concrete cone and splitting failure											
h_{ef}	Effective anchorage depth:	[mm]	26,0	30,0	43,0	37,5	50,5	41,5	58,5	67,0	
$k_{ucr,N}$	Factor for uncracked concrete:	[-]	11,0								
$k_{cr,N}$	Factor for cracked concrete:	[-]	7,7								
$s_{cr,N}$	Concrete Spacing:	[mm]	3 x h_{ef}								
$c_{cr,N}$	cone failure Edge distance	[mm]	1,5 x h_{ef}								
$s_{cr,sp}$	Spitting Spacing:	[mm]	90	90	170	130	200	140	190	210	
$c_{cr,sp}$	failure Edge distance	[mm]	45	45	85	65	100	70	95	105	
γ_{inst}	Robustness:	[-]	1,2	1,2	1,0	1,2	1,0	1,0	1,0	10	

¹⁾ In absence of other national regulations

²⁾ Pull out failure is not decisive

Essential characteristics under static or quasi-static tension loads according to design method A				Performances					
				12		14		18	
h_{nom}	Nominal embedment depth:	[mm]		75	105	75	115	90	140
Tension loads: steel failure									
$N_{Rk,s}$	Characteristic resistance:	[kN]		74,48		105,45		161,56	
γ_{Ms}	Partial safety factor ¹⁾ :	[-]		1,4					
Tension loads: pull-out failure in concrete									
$N_{Rk,p}$	Characteristic resistance in C20/25 uncracked concrete:	[kN]		2)					
$N_{Rk,p}$	Characteristic resistance in C20/25 cracked concrete:	[kN]		2)					
ψ_c	Increasing factor for concrete	C30/37	[-]	1,16	1,22	1,21	1,20	1,22	1,17
		C40/50	[-]	1,29	1,41	1,39	1,37	1,40	1,32
		C50/60	[-]	1,40	1,58	1,55	1,51	1,57	1,42
Tension loads: concrete cone and splitting failure									
h_{ef}	Effective anchorage depth:	[mm]	58,0	83,5	58,0	92,0	69,5	112,0	
$k_{ucr,N}$	Factor for uncracked concrete:	[-]	11,0						
$k_{cr,N}$	Factor for cracked concrete:	[-]	7,7						
$s_{cr,N}$	Concrete Spacing:	[mm]	3 x h_{ef}						
$c_{cr,N}$	cone failure Edge distance	[mm]	1,5 x h_{ef}						
$s_{cr,sp}$	Spitting spacing:	[mm]	190	220	190	230	230	350	
$c_{cr,sp}$	failure Edge distance	[mm]	95	110	95	115	115	175	
γ_{inst}	Robustness:	[-]	1,0						

¹⁾ In absence of other national regulations

²⁾ Pull out failure is not decisive

THE screw anchor

Performances

Essential characteristics under static or quasi-static tension loads

**Annex
C3**

English translation prepared by IETcc

Table C3: Essential characteristics under static or quasi-static shear loads of design method A according to EN 1992-4

Essential characteristics under static or quasi-static shear loads according to design method A		Performances								
		6			8			10		
h_{nom}	Nominal embedment depth: [mm]	35	40	55	50	65	55	75	85	
Shear loads: steel failure without lever arm										
$V_{Rk,s}$	Characteristic resistance: [kN]	12,53			19,57			27,40		
k_7	Ductility factor: [--]	0,78	0,80	0,78	0,80			0,80		
γ_{Ms}	Partial safety factor ¹⁾ : [--]	1,5								
Shear loads: steel failure with lever arm										
$M^0_{Rk,s}$	Characteristic bending moment: [Nm]	21,6			44,6			78,3		
γ_{Ms}	Partial safety factor ¹⁾ : [-]	1,5								
Shear loads: concrete pryout failure										
k_8	Pryout factor: [mm]	2,05	1,44	1,15	1,80	1,27	1,95	1,32	2,00	
γ_{inst}	Installation safety factor: [--]	1,0								
Shear loads: concrete edge failure										
l_f	Effective length of fastener under shear loads: [mm]	26,0	30,0	43,0	37,5	50,5	41,5	58,5	67,0	
d_{nom}	Outside fastener diameter: [mm]	6			8			10		
γ_{inst}	Installation safety factor: [--]	1,0								

¹⁾ In absence of other national regulations

Essential characteristics under static or quasi-static shear loads according to design method A		Performances					
		12		14		18	
h_{nom}	Nominal embedment depth: [mm]	75	105	75	115	90	140
Shear loads: steel failure without lever arm							
$V_{Rk,s}$	Characteristic resistance: [kN]	37,24		52,72		80,78	
k_7	Ductility factor	1,00		1,00		1,00	
γ_{Ms}	Partial safety factor ¹⁾ : [--]	1,5					
Shear loads: steel failure with lever arm							
$M^0_{Rk,s}$	Characteristic bending moment: [Nm]	126,5		218,3		421,2	
γ_{Ms}	Partial safety factor ¹⁾ : [-]	1,5					
Shear loads: concrete pry-out failure							
k_8	Pry-out factor: [mm]	2,33	2,00	2,55	2,00	2,66	2,00
γ_{inst}	Installation safety factor: [--]	1,0					
Shear loads: concrete edge failure							
l_f	Effective length of fastener under shear loads: [mm]	58,0	83,5	58,0	92,0	69,5	112,0
d_{nom}	Outside fastener diameter: [mm]	12		14		18	
γ_{inst}	Installation safety factor: [--]	1,0					

¹⁾ In absence of other national regulations

THE screw anchor	Annex C4
Performances	
Essential characteristics under static or quasi-static shear loads	

English translation prepared by IETcc

Table C4: Displacements under service loads

Displacements under loads			Performances							
			6			8		10		
h_{nom}	Nominal embedment depth:	[mm]	35	40	55	50	65	55	75	85
Displacements under tension loads in uncracked concrete										
N	Service tension load:	[kN]	1,98	3,85	6,61	4,48	8,41	6,26	10,48	12,85
$\bar{\delta}_{N0}$	Short term displacement:	[mm]	0,03	0,05	0,05	0,04	0,05	0,06	0,09	0,10
$\bar{\delta}_{N\infty}$	Long term displacement:	[mm]	0,25	0,30	0,30	0,26	0,35	0,30	0,42	0,65
Displacements under tension loads in cracked concrete										
N	Service tension load:	[kN]	1,81	2,69	4,62	3,14	5,88	4,38	7,34	8,99
$\bar{\delta}_{N0}$	Short term displacement:	[mm]	0,08	0,09	0,10	0,09	0,20	0,11	0,35	0,44
$\bar{\delta}_{N\infty}$	Long term displacement:	[mm]	0,99	0,99	1,60	1,08	1,92	1,13	2,00	1,91
Displacements under shear loads in uncracked concrete										
V	Service shear load:	[kN]	5,97	5,54	5,97	9,32	9,32	12,21	13,05	13,05
$\bar{\delta}_{V0}$	Short term displacement:	[mm]	1,50	1,61	1,70	1,03	1,03	1,11	1,21	1,24
$\bar{\delta}_{V\infty}$	Long term displacement:	[mm]	2,25	2,41	2,55	1,54	1,54	1,66	1,81	1,86
Displacements under shear loads in cracked concrete										
V	Service shear load:	[kN]	4,46	3,88	5,32	6,78	7,47	8,55	9,68	13,05
$\bar{\delta}_{V0}$	Short term displacement:	[mm]	0,95	0,96	1,45	0,66	0,70	0,74	1,03	1,09
$\bar{\delta}_{V\infty}$	Long term displacement:	[mm]	1,42	1,44	2,17	0,99	1,05	1,11	1,54	1,63

Displacements under loads			Performances					
			12		14		18	
h_{nom}	Nominal embedment depth:	[mm]	75	105	75	115	90	140
Displacements under tension loads in uncracked concrete								
N	Service tension load:	[kN]	10,35	17,87	10,35	20,67	13,57	27,77
$\bar{\delta}_{N0}$	Short term displacement:	[mm]	0,10	0,11	0,12	0,15	0,17	0,23
$\bar{\delta}_{N\infty}$	Long term displacement:	[mm]	0,40	0,68	0,46	0,70	0,50	0,71
Displacements under tension loads in cracked concrete								
N	Service tension load:	[kN]	7,24	12,51	7,24	14,47	9,50	19,44
$\bar{\delta}_{N0}$	Short term displacement:	[mm]	0,24	0,46	0,34	0,51	0,41	0,55
$\bar{\delta}_{N\infty}$	Long term displacement:	[mm]	1,32	1,78	1,40	1,80	1,56	2,08
Displacements under shear loads in uncracked concrete								
V	Service shear load:	[kN]	17,73	17,73	25,10	25,10	36,10	38,47
$\bar{\delta}_{V0}$	Short term displacement:	[mm]	1,65	1,65	1,87	1,87	1,96	2,03
$\bar{\delta}_{V\infty}$	Long term displacement:	[mm]	2,48	2,48	2,81	2,81	2,94	3,05
Displacements under shear loads in cracked concrete								
V	Service shear load:	[kN]	16,88	17,73	18,47	25,10	25,27	38,47
$\bar{\delta}_{V0}$	Short term displacement:	[mm]	1,30	1,34	1,40	1,70	1,34	1,80
$\bar{\delta}_{V\infty}$	Long term displacement:	[mm]	1,95	2,01	2,10	2,55	2,01	2,70

THE screw anchor

Performances

Displacements under static or quasi-static tension and shear loads

**Annex
C5**

English translation prepared by IETcc

Table C5: Essential characteristics for seismic performance category C1

Essential characteristics for seismic performance category C1			Performances							
			6	8	10	12	14	18		
h_{nom}	Nominal embedment depth:	[mm]	40	55	50	65	85	105	115	140
Steel failure for tension and shear loads										
$N_{Rk,s,C1}$	Characteristic resistance:	[kN]	25,12	25,12	39,14	39,14	54,81	74,48	105,45	161,56
γ_{Ms}	Partial safety factor ¹⁾ :	[--]	1,4							
$V_{Rk,s,C1}$	Characteristic resistance:	[kN]	5,9	9,4	8,7	11,7	19,2	23,5	31,7	44,1
γ_{Ms}	Partial safety factor ¹⁾ :	[--]	1,5							
Pull out failure										
$N_{Rk,p,C1}$	Characteristic resistance in cracked concrete:	[kN]	5,0	5,0	6,2	8,8	14,7	18,2	23,2	35,3
γ_{inst}	Robustness:	[--]	1,2	1,0	1,2	1,0	1,0	1,0	1,0	1,0
Concrete cone failure										
h_{ef}	Effective depth:	[mm]	30,0	43,0	37,5	50,5	67,0	83,5	92,0	112,0
$s_{cr,N}$	Concrete Spacing:	[mm]	3 x h_{ef}							
$c_{cr,N}$	cone Edge failure distance:	[mm]	1,5 x h_{ef}							
γ_{inst}	Installation safety factor:	[--]	1,2	1,0	1,2	1,0	1,0	1,0	1,0	1,0
Concrete pry-out failure										
k_8	Pry-out factor:	[--]	1,44	1,15	1,80	1,27	2,00	2,00	2,00	2,00
γ_{inst}	Installation safety factor:	[--]	1,0							
Concrete edge failure										
l_f	Effective length of fastener under shear loads:	[mm]	30,0	43,0	37,5	50,5	67,0	83,5	92,0	112,0
d_{nom}	Outside fastener diameter:	[mm]	6	6	8	8	10	12	14	18
γ_{inst}	Installation safety factor:	[--]	1,0							

¹⁾ In absence of other national regulations

THE screw anchor

Performances

Essential characteristics for seismic performance category C1

**Annex
C6**

Table C6: Essential characteristics for seismic performance category C2

Essential characteristics for seismic performance category C2			Performances						
			6	8		10	12	14	18
h_{nom}	Nominal embedment depth:	[mm]	--	50	65	85	105	115	140
Steel failure for tension and shear loads									
$N_{Rk,s,C2}$	Characteristic resistance:	[kN]	--	39,14	39,14	54,81	74,48	105,45	161,56
γ_{Ms}	Partial safety factor ¹⁾ :	[--]	1,4						
$V_{Rk,s,C2}$	Characteristic resistance:	[kN]	--	8,4	11,7	19,2	23,5	31,7	44,1
γ_{Ms}	Partial safety factor ¹⁾ :	[--]	1,5						
Pull out failure									
$N_{Rk,p,C2}$	Characteristic resistance in cracked concrete:	[kN]	--	2,3	3,4	6,9	10,5	15,3	31,5
γ_{inst}	Robustness:	[--]	--	1,2	1,0	1,0	1,0	1,0	1,0
Concrete cone failure									
h_{ef}	Effective depth:	[mm]	--	37,5	50,5	67,0	83,5	92,0	112,0
$S_{Cr,N}$	Concrete Spacing:	[mm]	--	3 x h_{ef}					
$C_{Cr,N}$	cone failure Edge dist.:	[mm]	--	1,5 x h_{ef}					
γ_{inst}	Installation safety factor:	[--]	--	1,0					
Concrete pry-out failure									
k_8	Pry-out factor:	[--]	--	1,80	1,27	2,00	2,00	2,00	2,00
γ_{inst}	Installation safety factor:	[--]	--	1,0					
Concrete edge failure									
l_f	Effective length of fastener under shear loads:	[mm]	--	37,5	50,5	67,0	83,5	92,0	112,0
d_{nom}	Outside fastener diameter:	[mm]	--	8	8	10	12	14	18
γ_{inst}	Installation safety factor:	[--]	--	1,0					
Displacements									
$\delta_{N,C2} (DLS)$	Displacement Damage Limitation State: ²⁾	[mm]	--	0,36	0,16	0,22	0,41	0,25	0,66
$\delta_{V,C2} (DLS)$	Displacement Damage Limitation State: ²⁾	[mm]	--	1,60	0,79	1,13	1,69	1,52	1,69
$\delta_{N,C2} (ULS)$	Displacement Ultimate Limit State: ²⁾	[mm]	--	1,08	2,70	3,11	2,61	2,32	1,89
$\delta_{V,C2} (ULS)$	Displacement Ultimate Limit State: ²⁾	[mm]	--	2,54	4,74	7,43	9,03	6,29	8,79
DLS	Damage Limitation State: see EN 1992-4, 2.2.1)								
ULS	Ultimate Limitation State: see EN 1992-4 2.2.1)								

- 1) In absence of other national regulations
2) The listed displacements represent mean values

THE screw anchor

Performances

Essential characteristics for seismic performance category C2

**Annex
C7**

English translation prepared by IETcc

Table C7: Essential characteristics under fire exposure

Essential characteristics under fire exposure				Performances							
				6			8		10		
h_{nom}	Nominal embedment depth:	[mm]		35	40	55	50	65	55	75	85
Steel failure											
$N_{Rk,s,fi}$	Characteristic tension resistance:	R30	[kN]	0,26			0,45		1,07		
		R60	[kN]	0,23			0,41		0,93		
		R90	[kN]	0,18			0,32		0,71		
		R120	[kN]	0,13			0,23		0,57		
$V_{Rk,s,fi}$	Characteristic shear resistance:	R30	[kN]	0,26			0,45		1,07		
		R60	[kN]	0,23			0,41		0,93		
		R90	[kN]	0,18			0,32		0,71		
		R120	[kN]	0,13			0,23		0,57		
$M^0_{Rk,s,fi}$	Characteristic bending resistance:	R30	[kN]	0,22			0,52		1,52		
		R60	[kN]	0,20			0,46		1,32		
		R90	[kN]	0,16			0,36		1,02		
		R120	[kN]	0,11			0,26		0,81		
Pull out failure											
$N_{Rk,p,fi}$	Characteristic resistance:	R30 - R90	[kN]	1,25			2)				
		R120	[kN]	1,00							
		Concrete cone failure ¹⁾									
$N_{Rk,p,fi}$	Characteristic resistance:	R30 - R90	[kN]	0,59	0,85	2,09	1,48	3,12	1,91	4,51	6,33
		R120	[kN]	0,47	0,68	1,67	1,19	2,50	1,53	3,61	5,06
$S_{cr,N,fi}$	Critical spacing:	R30 - R120	[mm]	4 x h_{ef}							
$S_{min,fi}$	Minimum spacing:	R30 - R120	[mm]	35			35		50		
$C_{cr,N,fi}$	Critical edge distance:	R30 - R120	[mm]	2 x h_{ef}							
$C_{min,fi}$	Minimum edge distance:	R30 - R120	[mm]	$c_{min} = 2 \times h_{ef}$; if fire attack comes from more than one side, the edge distance of the anchor has to be ≥ 300 mm							
Concrete pry out failure											
k_8	Pry-out factor:	R30 - R120	[mm]	2,05	1,44	1,15	1,80	1,27	1,95	1,32	2,00

¹⁾ As a rule, splitting failure can be neglected since cracked concrete and reinforcement is assumed.

²⁾ Pull out failure is not decisive

In absence of other national regulations the partial safety factor for resistance under fire exposure $\gamma_{m,fi} = 1,0$ is recommended

THE screw anchor

Performances

Essential characteristics under fire exposure

**Annex
C8**

Table C8: Essential characteristics under fire exposure (cont)

Essential characteristics under fire exposure				Performances					
				12		14		18	
h_{nom}	Nominal embedment depth:	[mm]		75	105	75	115	90	140
Steel failure									
$N_{Rk,s,fi}$	Characteristic tension resistance:	R30	[kN]	2,01		2,99		4,73	
		R60	[kN]	1,51		2,24		3,56	
		R90	[kN]	1,31		1,94		3,07	
		R120	[kN]	1,01		1,50		2,37	
$V_{Rk,s,fi}$	Characteristic shear resistance:	R30	[kN]	2,01		2,99		4,74	
		R60	[kN]	1,51		2,24		3,56	
		R90	[kN]	1,31		1,94		3,08	
		R120	[kN]	1,01		1,50		2,37	
$M^0_{Rk,s,fi}$	Characteristic bending resistance:	R30	[Nm]	3,42		6,19		12,37	
		R60	[Nm]	2,56		4,64		9,28	
		R90	[Nm]	2,22		4,02		8,04	
		R120	[Nm]	1,71		3,10		6,18	
Pull out failure									
$N_{Rk,p,fi}$	Characteristic resistance:	R30 to R120	[kN]	2)					
Concrete cone failure ¹⁾									
$N_{Rk,p,fi}$	Characteristic resistance:	R30 - R90	[kN]	4,41	10,97	4,41	13,98	6,93	22,86
		R120	[kN]	3,53	8,78	3,53	11,18	5,55	18,29
$S_{cr,N,fi}$	Critical spacing:	R30 - R120	[mm]	4 x h_{ef}					
$S_{min,fi}$	Minimum spacing:	R30 - R120	[mm]	75		80		90	
$C_{cr,N,fi}$	Critical edge distance:	R30 - R120	[mm]	2 x h_{ef}					
$C_{min,fi}$	Minimum edge distance:	R30 - R120	[mm]	$C_{min} = 2 \times h_{ef}$; if fire attack comes from more than one side, the edge distance of the anchor has to be ≥ 300 mm					
Concrete pry out failure									
k_8	Pry-out factor:	R30 - R120	[mm]	2,33	2,00	2,55	2,00	2,66	2,00

¹⁾ As a rule, splitting failure can be neglected since cracked concrete and reinforcement is assumed.

²⁾ Pull out failure is not decisive

In absence of other national regulations the partial safety factor for resistance under fire exposure $\gamma_{m,fi} = 1,0$ is recommended

THE screw anchor	Annex C9
Performances	
Essential characteristics under fire exposure	