



**INSTITUTO DE CIENCIAS  
DE LA CONSTRUCCIÓN  
EDUARDO TORROJA**

C/ Serrano Galvache n. 4 28033 Madrid (Spain)  
Tel.: (34) 91 302 04 40 Fax: (34) 91 302 07 00  
direccion.ietcc@csic.es <https://dit.ietcc.csic.es>

## European Technical Assessment

## ETA 20/1268 of 30/12/2020

English translation prepared by IETcc. Original version in Spanish language

### General Part

**Technical Assessment Body issuing the ETA designated according to Art. 29 of Regulation (EU) 305/2011:**

Instituto de Ciencias de la Construcción Eduardo Torroja (IETcc)

**Trade name of the construction product:**

**Screw anchor THE**

**Product family to which the construction product belongs:**

Screw anchor of sizes 5 and 6 for use in concrete and in precast prestressed hollow core slabs for redundant non-structural systems

**Manufacturer:**

**Bilontec Industrial S.L.**  
Bizkargi 6  
Poligono Industrial Sarrikola  
48195 Larrabetzu (Bizkaia) Spain

**Manufacturing plant:**

Bilontec plant 2

**This European Technical Assessment contains:**

13 pages including 3 annexes which form an integral part of this assessment.

**This European Technical Assessment is issued in accordance with regulation (EU) No 305/2011, on the basis of:**

European Technical Assessment EAD 330747-00-0601 "Fasteners for use in concrete for redundant non-structural systems", ed. May 2018

*English translation prepared by IETcc*

This European Technical Assessment is issued by the Technical Assessment Body in its official language. Translations of this European Technical Assessment in other languages shall fully correspond to the original issued document and should be identified as such.

This European Technical Assessment may be withdrawn by the issuing Technical Assessment Body, in particular pursuant to information by the Commission according to article 25 (3) of Regulation (EU) No 305/2011.

English translation prepared by IETcc

## SPECIFIC PART

### 1. Technical description of the product

The Bilontec screw anchor B-THE is a fastener made of carbon steel of sizes 5 and 6. The fastener is installed into a predrilled cylindrical drilled hole. The special thread of the fastener cuts an internal thread into the concrete member while setting. The anchorage is characterised by mechanical interlock between fastener and concrete.

Product and installation descriptions are given in annexes A1 and A2.

### 2. Specification of the intended use in accordance with the applicable European Assessment Document.

The performances given in section 3 are only valid if the anchor is used in compliance with the specifications and conditions given in annex B.

The verifications and assessment methods on which this European Technical Assessment is based, lead to the assumption of a working life of the anchor of at least 50 years. The indications given on the working life cannot be interpreted as a guarantee given by the producer, but are to be regarded only as a mean to choosing the right products in relation to the expected economically reasonable working life of the works.

### 3. Performance of the product and references to the methods used for its assessment

#### 3.1 Safety in case of fire (BWR 2)

| Essential characteristic | Performance   |
|--------------------------|---|
| Reaction to fire         | Anchorage satisfies requirements for class A1 according to EN 13501-7 |
| Resistance to fire       | See annex C5  |

#### 3.2 Safety in use (BWR 4)

| Essential characteristic                                       | Performance         |
|--|---------------------|
| Characteristic resistance under static or quasi static loading | See annex C3 and C4 |

### 4. Assessment and Verification of Constancy of Performance (hereinafter AVCP) system applied, with reference to its legal base

The applicable European legal act for the system of Assessment and Verification of Constancy of Performance (see annex V to Regulation (EU) No 305/2011) is 97/161/EC.

The system to be applied is 2+.

English translation prepared by IETcc

**5. Technical details necessary for the implementation of the AVCP system, as provided for in the applicable European Assessment Document.**

The technical details necessary for the implementation of the AVCP system are laid down in the quality plan deposited at Instituto de Ciencias de la Construcción Eduardo Torroja.



Instituto de Ciencias de la Construcción Eduardo Torroja  
CONSEJO SUPERIOR DE INVESTIGACIONES CIENTÍFICAS

C/ Serrano Galvache n.º 4. 28033 Madrid.  
Tel: (+34) 91 302 04 40 Fax. (+34) 91 302 07 00  
<https://dit.ietcc.csic.es>







On behalf of the Instituto de Ciencias de la Construcción Eduardo Torroja  
Madrid, 30<sup>th</sup> of December 2020

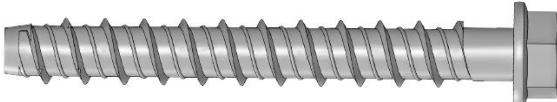
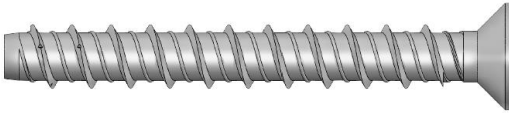
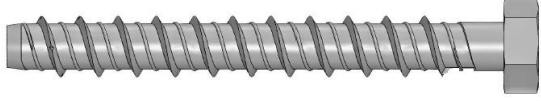
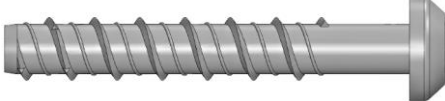
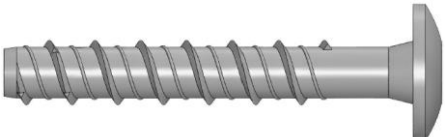
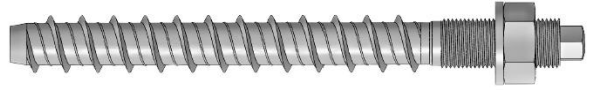

Director IETcc-CSIC

English translation prepared by IETcc

**Product types**

| Picture   | Sizes  | Code  | Coating     |
|---|--|-------|-------------|
|    | Hexagonal head with flange                             | B-THE | Atlantis    |
|   |  | B-TFE | Zinc plated |
|   |  | B-TNE | Zinc nickel |
|   |  | B-TKE | Zinc flake  |
|    | Countersunk, Six lob recess                            | B-THA | Atlantis    |
|   |  | B-TFA | Zinc plated |
|   |  | B-TNA | Zinc nickel |
|   |  | B-TKA | Zinc flake  |
|    | Hexagonal head   | B-THN | Atlantis    |
|   |  | B-TFN | Zinc plated |
|   |  | B-TNN | Zinc nickel |
|   |  | B-TKN | Zinc flake  |
|    | Pan head. Six lob recess                               | B-THT | Atlantis    |
|   |  | B-TFT | Zinc plated |
|   |  | B-TNT | Zinc nickel |
|   |  | B-TKT | Zinc flake  |
|  | Truss head. Six lob recess                             | B-THP | Atlantis    |
|   |  | B-TFP | Zinc plated |
|   |  | B-TNP | Zinc nickel |
|   |  | B-TKP | Zinc flake  |
|  | Stud head with DIN 934 class 6 nut and DIN 125 washer  | B-TFW | Zinc plated |
|   |  | B-TNW | Zinc nickel |
|   |  | B-TKW | Zinc flake  |
|  | Stud head  | B-TFS | Zinc plated |
|   |  | B-TNS | Zinc nickel |
|   |  | B-TKS | Zinc flake  |
|  | Male thread<br>External thread M8; M10                 | B-TFM | Zinc plated |
|   |  | B-TNM | Zinc nickel |
|   |  | B-TKM | Zinc flake  |
|  | Female thread (rod hanger)<br>Internal thread M8 / M10 | B-TFF | Zinc plated |
|   |  | B-TNF | Zinc nickel |
|   |  | B-TKF | Zinc flake  |

**B-THE screw anchor**

**Product description**

Screw types

**Annex  
A1**

English translation prepared by IETcc

**Installed condition in concrete**

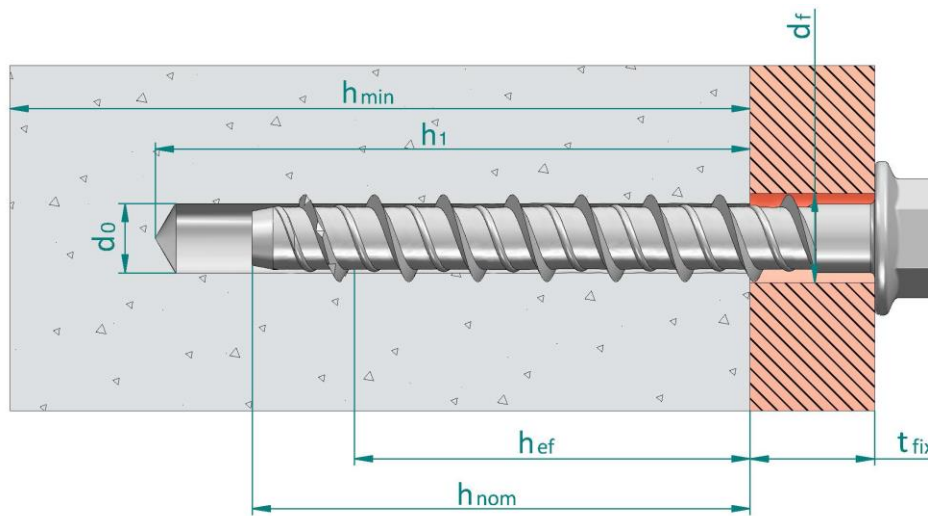

- $d_0$ : Nominal diameter of drill bit
- $d_f$ : Fixture clearance hole diameter
- $h_{ef}$ : Effective anchorage depth
- $h_1$ : Depth of drilled hole
- $h_{nom}$ : Overall fastener embedment depth in the concrete
- $h_{min}$ : Minimum thickness of concrete member
- $t_{fix}$ : Fixture thickness

Identification on head of fastener: company logo + size x length

The tip of the thread may be coloured

For heads where no space enough space is available, length mark can be replaced by the following letter codes.

| Letter on head | Length [mm] |
|----------------|-------------|
| A              | 35 ÷ 50     |
| B              | 51 ÷ 62     |
| C              | 63 ÷ 75     |
| D              | 76 ÷ 88     |
| E              | 89 ÷ 101    |
| F              | 102 ÷ 113   |
| G              | 114 ÷ 126   |
| H              | 127 ÷ 139   |
| I              | 140 ÷ 153   |

**B-THE screw anchor**

**Product description**

Installed condition in concrete

**Annex  
A2**

English translation prepared by IETcc

**Installed condition in precast prestressed hollow core concrete slabs**

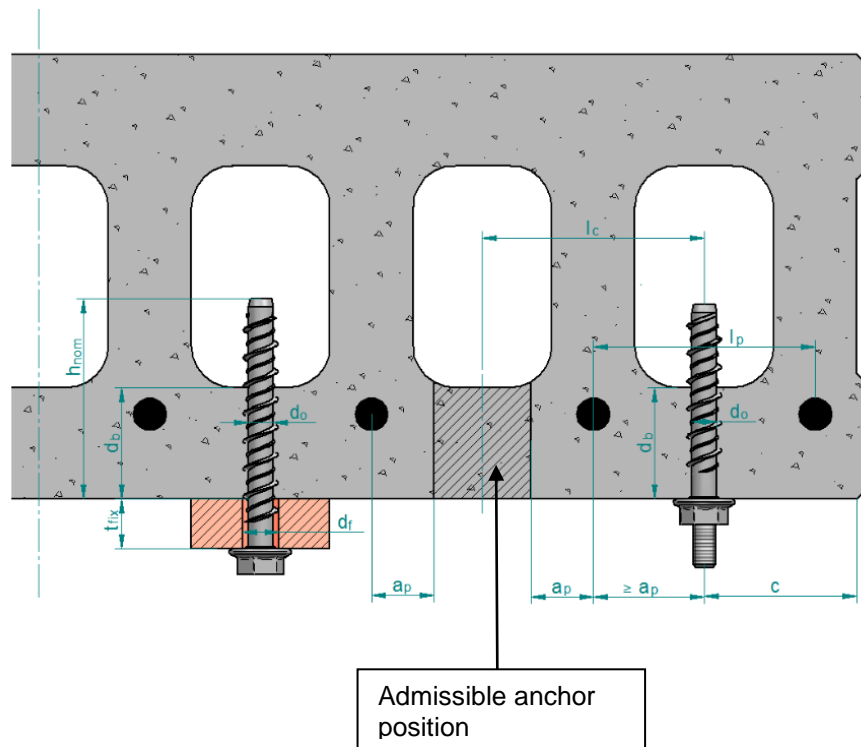

- $d_o$ : Nominal diameter of drill bit
- $d_f$ : Fixture clearance hole diameter
- $d_b$ : Bottom flange thickness
- $a_p$ : Distance between anchor position and prestressing steel  $\geq 50$  mm
- $l_c$ : Core distance  $\geq 100$  mm
- $l_p$ : Steel reinforcement distance  $\geq 100$  mm
- $t_{fix}$ : Fixture thickness
- $c$ : Edge distance

**Table A1: Materials**

| Item | Designation   | Material for screw anchor   |
|------|---------------|---|
| 1    | Fastener body | Carbon steel, galvanized $\geq 5 \mu\text{m}$ ISO 4042 Zn5<br>Carbon steel, zinc nickel $\geq 8 \mu\text{m}$ ISO 4042, ZnNi8/An/T2<br>Carbon steel, zinc flake $\geq 6 \mu\text{m}$ ISO 10683<br>Carbon steel, Atlantis coating |

**B-THE screw anchor**

**Product description**

Installed condition in prestressed hollow core slabs and materials

**Annex  
 A3**

### **Specifications of intended use**

#### **Anchorage subjected to:**

- Static or quasi static loads for redundant non-structural systems
- Use for anchorages with requirements related to resistance of fire (not for using in prestressed hollow core slabs)
- The anchor may only be used if in the design and installation specifications for the fixture the excessive slip or failure of one anchor will not result in a significant violation of the requirements on the fixture in the serviceability and ultimate state.

#### **Base materials:**

- Reinforced or unreinforced normal weight concrete according to EN 206:2013.
- Strength classes C20/25 to C50/60 according to EN 206:2013.
- Cracked or uncracked concrete.
- Precast, prestressed hollow core concrete slabs, strength C30/37 to C50/60 according to EN 206:2013

#### **Use conditions (environmental conditions):**

- Anchorages subjected to dry internal conditions.

#### **Design:**

- Anchorages are designed under the responsibility of an engineer experienced in anchorages and concrete work.
- Verifiable calculation rules and drawings are prepared taking into account of the loads to be anchored. The position of the fastener is indicated on the design drawings (e.g. position of the fastener relative to reinforcement or to supports, etc.).
- Anchorages under static or quasi-static actions are designed for design method A in accordance with EN 1992-4:2018.
- Anchorages under fire exposure are designed in accordance with EN 1992-4:2018. It must be ensured that local spalling of the concrete cover does not occur.

#### **Installation:**

- Hole drilling by rotary plus hammer mode.
- Fastener installation carried out by appropriately qualified personal and under the supervision of the person responsible for technical matters of the site.
- In case of aborted hole: new drilling at a minimum distance away of twice the depth of aborted hole or smaller distance if the aborted hole is filled with high strength mortar and if under shear or oblique tension load it is not the direction of the load application.
- After installation further turning of the anchor must not be possible.
- The head of the fastener must be supported on the fixture and is not damaged.

|                         |                     |
|-------------------------|---------------------|
| <b>THE screw anchor</b> | <b>Annex<br/>B1</b> |
| <b>Intended use</b>     |                     |
| Specifications          |                     |



English translation prepared by IETcc

**Table C1: Installation parameters in concrete**

| Installation parameters in concrete |  |                   | Performances   |      |      |      |
|-------------------------------------|--|-------------------|--|------|------|------|
|                                     |  |                   | 5  |      | 6    |      |
| $h_{nom}$                           | Nominal embedment depth:                 | [mm]              | 35   | 45   | 35   | 55   |
| $h_{ef}$                            | Effective anchorage depth:               | [mm]              | 26.5   | 35.0 | 26.0 | 43.0 |
| $d_0$                               | Nominal diameter of drill bit:           | [mm]              | 5  |      | 6    |      |
| $d_f$                               | Clearance hole diameter $\leq$           | [mm]              | 8  |      | 9    |      |
| $T_{inst,max}$                      | Installation torque $\leq$               | [Nm]              | 5  |      | 10   |      |
| $h_1$                               | Depth of drilled hole $\geq$             | [mm]              | 45   | 55   | 45   | 65   |
| $h_{min}$                           | Minimum thickness of concrete member:    | [mm]              | 80   | 80   | 80   | 90   |
| $L_{min}$                           | Total length of the fastener:            | [mm]              | 42   | 52   | 40   | 60   |
| $L_{max}$                           |  | [mm]              | 100  | 120  | 150  | 150  |
| $t_{fix}$                           | Thickness of fixture <sup>1</sup> $\leq$ | [mm]              | L-35   | L-45 | L-35 | L-55 |
| SW                                  | Socket size                              | B-THE, B-TFE [mm] | 8  |      | 10   |      |
|                                     |  | B-TFF, B-TFM [mm] | --   |      | 13   |      |
|                                     |  | B-TFS [mm]        | --   |      | 5    |      |
| TX                                  | Six lob recess                           | B-THA [--]        | 25   |      | 30   |      |
|                                     |  | B-THP [--]        | 30   |      | 40   |      |
|                                     |  | B-THT [--]        | --   |      | 30   |      |
| $d_k$                               | Diameter of countersunk head:            | [mm]              | 10.4   |      | 12.4 |      |
| $s_{min}$                           | Minimum allowable spacing:               | [mm]              | 35   |      | 35   |      |
| $c_{min}$                           | Minimum allowable distance:              | [mm]              | 35   |      | 35   |      |
| Setting tool                        |  |                   | Bosch GDS 18E, 500 W. $T_{impact,max}$ 250 Nm, or equivalent |      |      |      |

<sup>1)</sup> L = total fastener length

**Table C2: Installation parameters in prestressed hollow core concrete slabs**

| Installation parameters in prestressed hollow core concrete slabs |                                |                   | Performances   |    |    |      |    |    |
|---|--------------------------------|-------------------|--|----|----|------|----|----|
|   |                                |                   | 5  |    |    | 6    |    |    |
| $d_0$   | Nominal diameter of drill bit: | [mm]              | 5  |    |    | 6    |    |    |
| $d_f$   | Clearance hole diameter $\leq$ | [mm]              | 8  |    |    | 9    |    |    |
| $T_{inst,max}$  | Installation torque $\leq$     | [Nm]              | 5  |    |    | 10   |    |    |
| $h_1$   | Depth of drilled hole $\geq$   | [mm]              | 30   | 40 | 45 | 30   | 40 | 45 |
| $d_c$   | Minimum slab member thickness: | [mm]              | 25   | 30 | 40 | 25   | 30 | 40 |
| $L_{min}$   | Total length of the fastener:  | [mm]              | 42   |    |    | 40   |    |    |
| $L_{max}$   |                                | [mm]              | 100  |    |    | 150  |    |    |
| SW  | Socket size                    | B-THE, B-TFE [mm] | 8  |    |    | 10   |    |    |
|   |                                | B-TFF, B-TFM [mm] | --   |    |    | 13   |    |    |
|   |                                | B-TFS [mm]        | --   |    |    | 5    |    |    |
| TX  | Six lob recess                 | B-THA [--]        | 25   |    |    | 30   |    |    |
|   |                                | B-THP [--]        | 30   |    |    | 40   |    |    |
|   |                                | B-THT [--]        | --   |    |    | 30   |    |    |
| $d_k$   | Diameter of countersunk head:  | [mm]              | 10.4   |    |    | 12.4 |    |    |
| $s_{min}$   | Minimum allowable spacing:     | [mm]              | 35   |    |    | 35   |    |    |
| $c_{min}$   | Minimum allowable distance:    | [mm]              | 35   |    |    | 35   |    |    |
| Setting tool  |                                |                   | Bosch GDS 18E, 500 W. $T_{impact,max}$ 250 Nm, or equivalent |    |    |      |    |    |

<sup>1)</sup> L = total fastener length

**B-THE screw anchor**

**Performances**

Installation parameters

**Annex  
C1**

**Installation procedure**

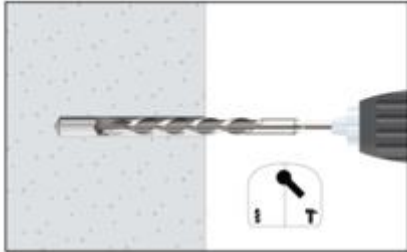

**1. DRILL**

Drill a hole into the base material of the correct diameter and depth using a carbide drill bit in rotary plus hammer mode.



**2. BLOW AND CLEAN**

Remove dust and debris from hole using a hand pump, compressed air or a vacuum to remove loose particles left from drilling.

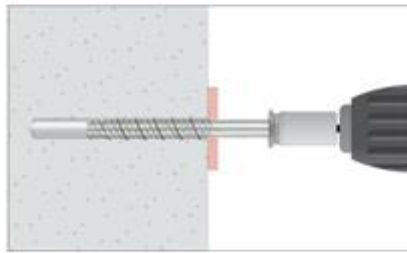

**3. INSTALL**

Select a powered impact wrench or a torque wrench that does not exceed the maximum torque  $T_{\text{impact,max}}$  or  $T_{\text{inst,max}}$  respectively. Attach an appropriate sized hex socket or six lob bit to the wrench. Mount the screw anchor head in the socket / bit.

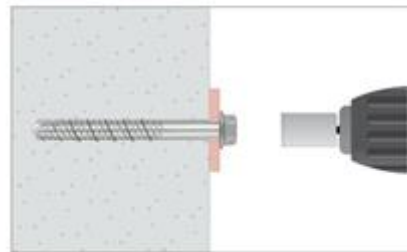

**4. APPLY TORQUE**

Drive the anchor with an impact driver or a torque wrench through the fixture and into the hole until the anchor head comes in contact with the fixture. The anchor must be snug after installation. Do not spin the socket off the anchor to disengage.

|                           |                     |
|---------------------------|---------------------|
| <b>B-THE screw anchor</b> | <b>Annex<br/>C2</b> |
| <b>Performances</b>       |                     |
| Installation procedure    |                     |

**Table C3: Characteristic values to tension loads in concrete of design method A according to EN 1992-4**

| Characteristic values of resistance to tension loads according to design method A |  | Performances   |      |      |      |      |
|---|--|----------------|------|------|------|------|
|   |  | 5              |      | 6    |      |      |
| $h_{nom}$   | Nominal embedment depth: [mm]                                | 35             | 45   | 35   | 55   |      |
| <b>Tension loads: steel failure</b>   |  |                |      |      |      |      |
| $N_{Rk,s}$  | Characteristic resistance: [kN]                              | 17.8           |      | 25.2 |      |      |
| $\gamma_{Ms}$   | Partial safety factor <sup>1)</sup> : [-]                    | 1.4            |      | 1.4  |      |      |
| <b>Tension loads: pull-out failure in concrete</b>                                |  |                |      |      |      |      |
| $N_{Rk,p}$  | Characteristic resistance in C20/25 uncracked concrete: [kN] | 2)             |      |      |      |      |
| $N_{Rk,p}$  | Characteristic resistance in C20/25 cracked concrete: [kN]   | 2)             |      |      |      |      |
| $\psi_c$  | Increasing factor for concrete                               | C30/37 [--]    | 1.14 | 1.02 | 1.15 | 1.22 |
|   |  | C40/45 [--]    | 1.26 | 1.04 | 1.27 | 1.41 |
|   |  | C50/60 [--]    | 1.38 | 1.05 | 1.38 | 1.58 |
| <b>Tension loads: concrete cone and splitting failure</b>                         |  |                |      |      |      |      |
| $h_{ef}$  | Effective anchorage depth: [mm]                              | 26.5           | 35.0 | 26.0 | 43.0 |      |
| $k_{ucr,N}$   | Factor for uncracked concrete: [-]                           | 11.0           |      |      |      |      |
| $k_{cr,N}$  | Factor for cracked concrete: [-]                             | 7.7            |      |      |      |      |
| $s_{cr,N}$  | Concrete Spacing: [mm]                                       | 3 x $h_{ef}$   |      |      |      |      |
| $c_{cr,N}$  | cone failure Edge distance [mm]                              | 1,5 x $h_{ef}$ |      |      |      |      |
| $s_{cr,sp}$   | Spitting Spacing: [mm]                                       | 80             | 105  | 90   | 170  |      |
| $c_{cr,sp}$   | failure Edge distance [mm]                                   | 40             | 52.5 | 45   | 85   |      |
| $\gamma_{inst}$   | Installation safety factor: [--]                             | 1.0            | 1.0  | 1.2  | 1.0  |      |

<sup>1)</sup> In absence of other national regulations

<sup>2)</sup> Pull out failure is not decisive

**Table C4: Characteristic values to shear loads in concrete of design method A according to EN 1992-4**

| Characteristic values of resistance to shear loads according to design method A |  | Performances |    |       |      |
|---|--|--------------|----|-------|------|
|   |  | 5            |    | 6     |      |
| $h_{nom}$   | Nominal embedment depth: [mm]                        | 35           | 45 | 35    | 55   |
| <b>Shear loads: steel failure without lever arm</b>                             |  |              |    |       |      |
| $V_{Rk,s}$  | Characteristic resistance: [kN]                      | 8.19         |    | 12.53 |      |
| $k_7$   | Ductility factor: [--]                               | 0.8          |    |       |      |
| $\gamma_{Ms}$   | Partial safety factor <sup>1)</sup> : [--]           | 1.5          |    |       |      |
| <b>Shear loads: steel failure with lever arm</b>                                |  |              |    |       |      |
| $M^0_{Rk,s}$  | Characteristic bending moment: [Nm]                  | 11.86        |    | 21.6  |      |
| $\gamma_{Ms}$   | Partial safety factor <sup>1)</sup> : [-]            | 1.5          |    |       |      |
| <b>Shear loads: concrete pryout failure</b>                                     |  |              |    |       |      |
| $k_8$   | Pryout factor: [mm]                                  | 1.0          |    |       |      |
| $\gamma_{ins}$  | Installation safety factor: [--]                     | 1.0          |    |       |      |
| <b>Shear loads: concrete edge failure</b>                                       |  |              |    |       |      |
| $l_f$   | Effective length of fastener under shear loads: [mm] | 26.5         | 35 | 26.0  | 43.0 |
| $d_{nom}$   | Outside fastener diameter: [mm]                      | 5            |    | 6     |      |
| $\gamma_{inst}$   | Installation safety factor: [--]                     | 1.0          |    |       |      |

<sup>1)</sup> In absence of other national regulations

**B-THE screw anchor**

**Performances**

Characteristic values for tension and shear loads in concrete

**Annex  
C3**

English translation prepared by IETcc

**Table C5: Characteristic values to tension loads in precast, prestressed hollow core slabs C30/37 to C50/60 of design method A according to EN 1992-4**

| Characteristic values of resistance to tension loads according to design method A |   | Performances   |    |      |      |    |    |
|---|---|----------------|----|------|------|----|----|
|   |   | 5              |    |      | 6    |    |    |
| $d_b$   | Minimum bottom flange thickness: [mm]                         | 25             | 30 | 40   | 25   | 30 | 40 |
| <b>Tension loads: steel failure</b>   |   |                |    |      |      |    |    |
| $N_{Rk,s}$  | Characteristic resistance: [kN]                               | 16.4           |    |      | 25.2 |    |    |
| $\gamma_{Ms}$   | Partial safety factor <sup>1)</sup> : [-]                     | 1.4            |    |      | 1.4  |    |    |
| <b>Tension loads: pull-out failure in concrete</b>                                |   |                |    |      |      |    |    |
| $N_{Rk,p}$  | Characteristic resistance in hollow core concrete slab:: [kN] | 2)             |    |      |      |    |    |
| <b>Tension loads: concrete cone and splitting failure</b>                         |   |                |    |      |      |    |    |
| $h_{ef}$  | Effective anchorage depth: [mm]                               | 20             | 22 | 26.5 | 20   | 22 | 26 |
| $k_{ucr,N}$   | Factor for uncracked concrete: [-]                            | 11.0           |    |      |      |    |    |
| $s_{cr,N}$  | Concrete Spacing: [mm]  | 3 x $h_{ef}$   |    |      |      |    |    |
| $c_{cr,N}$  | cone failure Edge distance [mm]                               | 1,5 x $h_{ef}$ |    |      |      |    |    |
| $s_{cr,sp}$   | Spitting Spacing: [mm]  | 80             |    |      | 90   |    |    |
| $c_{cr,sp}$   | failure Edge distance [mm]                                    | 40             |    |      | 45   |    |    |
| $\gamma_{inst}$   | Installation safety factor: [--]                              | 1.2            |    |      | 1.2  |    |    |

<sup>1)</sup> In absence of other national regulations

<sup>2)</sup> Pull out failure is not decisive

**Table C6: Characteristic values to shear loads in precast, prestressed hollow core slabs C30/37 to C50/60 of design method A according to EN 1992-4**

| Characteristic values of resistance to shear loads according to design method A |  | Performances |    |      |      |    |    |
|---|--|--------------|----|------|------|----|----|
|   |  | 5            |    |      | 6    |    |    |
| $d_b$   | Minimum bottom flange thickness: [mm]                | 25           | 30 | 40   | 25   | 30 | 40 |
| <b>Shear loads: steel failure without lever arm</b>                             |  |              |    |      |      |    |    |
| $V_{Rk,s}$  | Characteristic resistance: [kN]                      | 8.2          |    |      | 12.5 |    |    |
| $\gamma_{Ms}$   | Partial safety factor <sup>1)</sup> : [--]           | 1.5          |    |      | 1.5  |    |    |
| <b>Shear loads: steel failure with lever arm</b>                                |  |              |    |      |      |    |    |
| $M^0_{Rk,s}$  | Characteristic bending moment: [Nm]                  | 11.9         |    |      | 21.6 |    |    |
| $\gamma_{Ms}$   | Partial safety factor <sup>1)</sup> : [-]            | 1.5          |    |      | 1.5  |    |    |
| <b>Shear loads: concrete pryout failure</b>                                     |  |              |    |      |      |    |    |
| $k_8$   | Pryout factor: [mm]                                  | 1.0          |    |      |      |    |    |
| $\gamma_{ins}$  | Installation safety factor: [--]                     | 1.0          |    |      |      |    |    |
| <b>Shear loads: concrete edge failure</b>                                       |  |              |    |      |      |    |    |
| $l_f$   | Effective length of fastener under shear loads: [mm] | 20           | 22 | 26.5 | 20   | 22 | 26 |
| $d_{nom}$   | Outside fastener diameter: [mm]                      | 5            |    |      | 6    |    |    |
| $\gamma_{inst}$   | Installation safety factor: [--]                     | 1.0          |    |      |      |    |    |

<sup>1)</sup> In absence of other national regulations

|  |                     |
|--|---------------------|
| <b>B-THE screw anchor</b>  | <b>Annex<br/>C4</b> |
| <b>Performances</b>  |                     |
| Characteristic values for tension and shear loads in prestressed hollow core slabs |                     |

English translation prepared by IETcc

**Table C7: Characteristic values for resistance to fire in concrete**

| Characteristic values for resistance to fire in concrete |                                    |            |      | Performances  |      |
|--|------------------------------------|------------|------|---|------|
|  |                                    |            |      | 6   |      |
| $h_{nom}$  | Nominal embedment depth:           | [mm]       |      | 35  | 55   |
| <b>Steel failure</b>                                     |                                    |            |      |   |      |
| $N_{Rk,s,fi}$  | Characteristic tension resistance: | R30        | [kN] | 0.26  |      |
|  |                                    | R60        | [kN] | 0.23  |      |
|  |                                    | R90        | [kN] | 0.18  |      |
|  |                                    | R120       | [kN] | 0.13  |      |
| $V_{Rk,s,fi}$  | Characteristic shear resistance:   | R30        | [kN] | 0.26  |      |
|  |                                    | R60        | [kN] | 0.23  |      |
|  |                                    | R90        | [kN] | 0.18  |      |
|  |                                    | R120       | [kN] | 0.13  |      |
| $M^0_{Rk,s,fi}$  | Characteristic bending resistance: | R30        | [kN] | 0.22  |      |
|  |                                    | R60        | [kN] | 0.20  |      |
|  |                                    | R90        | [kN] | 0.16  |      |
|  |                                    | R120       | [kN] | 0.11  |      |
| <b>Pull out failure</b>                                  |                                    |            |      |   |      |
| $N_{Rk,p,fi}$  | Characteristic resistance:         | R30 - R120 | [kN] | 2)  |      |
| <b>Concrete cone failure <sup>1)</sup></b>               |                                    |            |      |   |      |
| $N_{Rk,p,fi}$  | Characteristic resistance:         | R30 - R90  | [kN] | 0.59  | 2.09 |
|  |                                    | R120       | [kN] | 0.47  | 1.67 |
| $s_{cr,N,fi}$  | Critical spacing:                  | R30 - R120 | [mm] | $4 \times h_{ef}$   |      |
| $s_{min,fi}$   | Minimum spacing:                   | R30 - R120 | [mm] | 35  |      |
| $c_{cr,N,fi}$  | Critical edge distance:            | R30 - R120 | [mm] | $2 \times h_{ef}$   |      |
| $c_{min,fi}$   | Minimum edge distance:             | R30 - R120 | [mm] | $c_{min} = 2 \times h_{ef}$ ; if fire attack comes from more than one side, the edge distance of the anchor has to be $\geq 300$ mm |      |
| <b>Concrete pry out failure</b>                          |                                    |            |      |   |      |
| $k_8$  | Pry-out factor:                    | R30 - R120 | [mm] | 1.0   |      |

<sup>1)</sup> As a rule, splitting failure can be neglected since cracked concrete and reinforcement is assumed.

<sup>2)</sup> Pull out failure is not decisive

In absence of other national regulations the partial safety factor for resistance under fire exposure  $\gamma_{m,fi} = 1,0$  is recommended

**B-THE screw anchor**

**Performances**

Characteristic values for resistance to fire in concrete

**Annex  
C5**